

Operating Guide

April 2008



1 Safety

This manual represents your meter as manufactured at the time of publication. It assumes standard software. Special versions of software may be fitted, in which case you will be provided with additional details.

Every effort has been made to ensure that the information in this manual is complete and accurate. We revised this manual but cannot be held responsible for errors or omissions.

The apparatus has been designed and tested in accordance with EN 61010-1, 'Safety Requirements for Electrical Equipment for Measurement, Control and Laboratory Use'. This operating guide contains information and warnings which must be followed by the user to ensure safe operation and to maintain the apparatus in a safe condition.

We reserve the right to make changes and improvements to the product without obligation to incorporate these changes and improvements into units previously shipped.

1.1 Warning Symbols

This instruction manual gives details of safe installation and operation of the **Cube400** electricity meter. Safety may be impaired if the instructions are not followed. Labels on each meter give details of equipment ratings for safe operation. Take time to examine all labels before commencing installation. Safety symbols on the meter have specific meanings.



Refer To User Manual

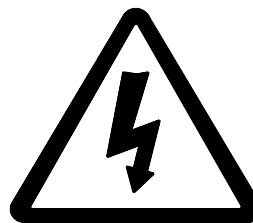

Risk of Electric Shock

WARNING

The meter contains no user serviceable parts.
Installation and commissioning should only be carried out by qualified personnel

1.2 Maintenance

The equipment should be maintained in good working order. Damage to the product should be repaired by the manufacturer. The meter may be cleaned by wiping lightly with a soft cloth. No solvents or cleaning agents should be used. All inputs and supplies must be isolated before cleaning any part of the equipment.

Further information is available at <http://www.ndmeter.co.uk>.

1.3 Waste Electrical/Electronic Equipment

At the end of this products useful life it should be disposed of ONLY via a recycling center as defined by the EU WEEE directive. This product should not be incinerated.

2 Display Pages

Measured data is displayed on numerous pages organised in four Standard Menus and two Distortion Menus as follows:

2.1 Power Up

The following screen is shown when auxiliary power is first supplied.

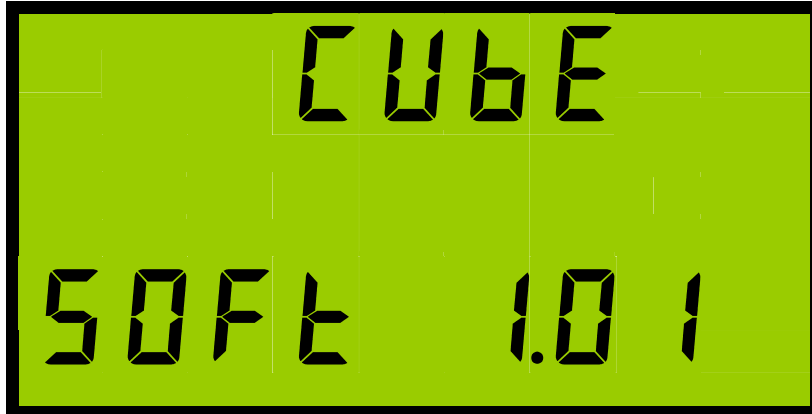

2.2 Current Menu

Press the  key to select from the available Current Menu pages.

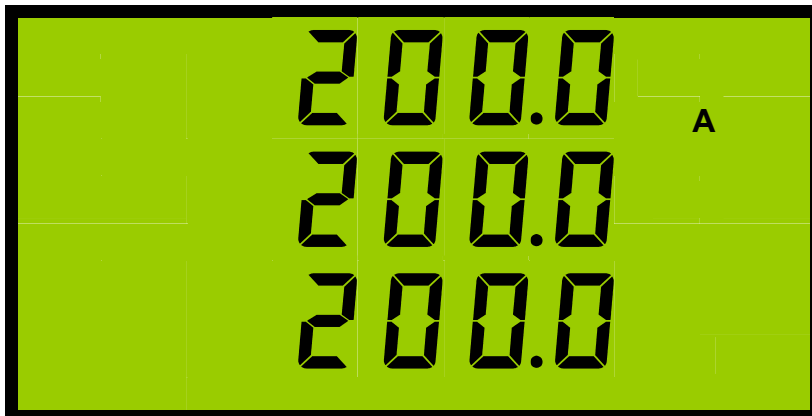

Phase Amps

Phase 1 true rms amps

Phase 2 true rms amps.

Phase 3 true rms amps.

This display is updated every second.



Peak Hold Phase Amps

The maximum value of displayed phase amps. These are stored in non-volatile memory when the meter loses auxiliary power

Press  and  to reset all three maximums to zero ^{note 1}.



Time-Averaged Amps

The calculated average of phase amps taken over a user definable time period T_{VI} (10s to 1800s).

A rolling time window is used and the display updated every $T_{VI}/10$ with the average of the most recent period displayed.



Peak Time-Averaged Amps

The maximum value of Time-Averaged amps. These are stored in non-volatile memory when the meter loses auxiliary power

Press  and  to reset all three maximums to zero ^{note 1}.

2.3 Voltage Menu

Press the  key to select from the available Voltage Menu pages.



Phase Volts

Phase 1 to neutral true rms volts
 Phase 2 to neutral true rms volts.
 Phase 3 to neutral true rms volts.
 This display is updated every second.



Line Volts

Line 1 true rms volts (Phases 1-2)
 Line 2 true rms volts (Phases 2-3)
 Line 3 true rms volts (Phases 3-1)
 This display is updated every second.

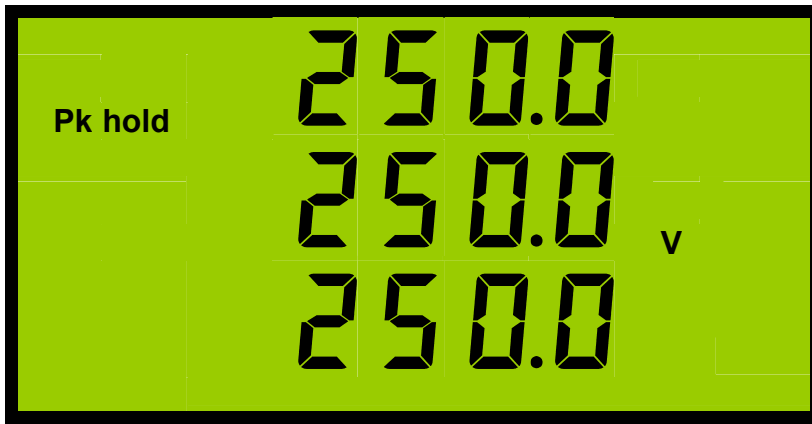

Peak Hold Phase Volts

The maximum value of displayed phase volts. These are stored in non-volatile memory when the meter loses auxiliary power

Press  and  to reset all three maximums to zero ^{note 1}.



Time-Averaged Volts

The calculated average of phase volts taken over a user definable time period T_{VI} (10s to 1800s).

A rolling time window is used and the display updated every $T_{VI}/10$ with the average of the most recent period displayed.

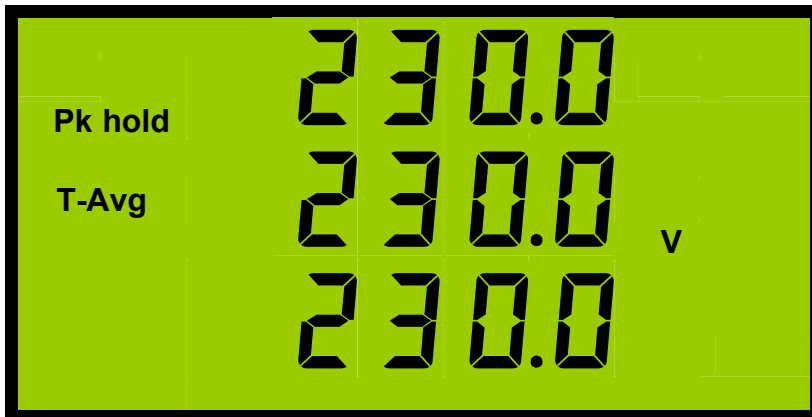

Peak Time-Averaged Volts

The maximum value of Time-Averaged volts. These are stored in non-volatile memory when the meter loses auxiliary power

Press  and  to reset all three maximums to zero ^{note 1}.

2.4 Power Menu

Press the  key to select from the available Power Menu pages.



System Power

System Reactive Power (var)

System Active Power (VA)

System Real Power (Watts)

A  symbol after the var value indicates a capacitive load.

A negative sign before the var readings indicates export reactive power.



Phase Watts

Phase 1 true rms watts

Phase 2 true rms watts.

Phase 3 true rms watts

A negative sign before the watt readings indicates export power.



System Page 2

Balance current. (I1+I2+I3)

Frequency (Measured on V1)

System Power Factor

A  symbol after the power factor value indicates a capacitive load.



Phase VA

Phase 1 true rms VA

Phase 2 true rms VA.

Phase 3 true rms VA

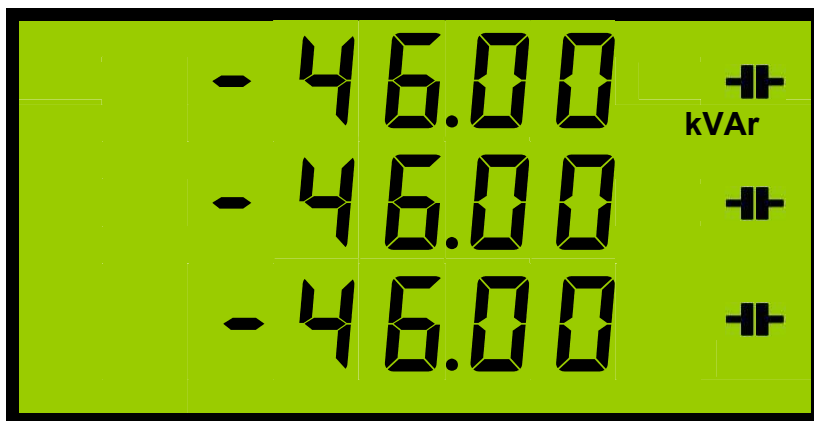

Phase var

Phase 1 true rms var.
Phase 2 true rms var.
Phase 3 true rms var.

A  symbol after a var value indicates a capacitive load.

A negative sign before a var reading indicates export reactive power.

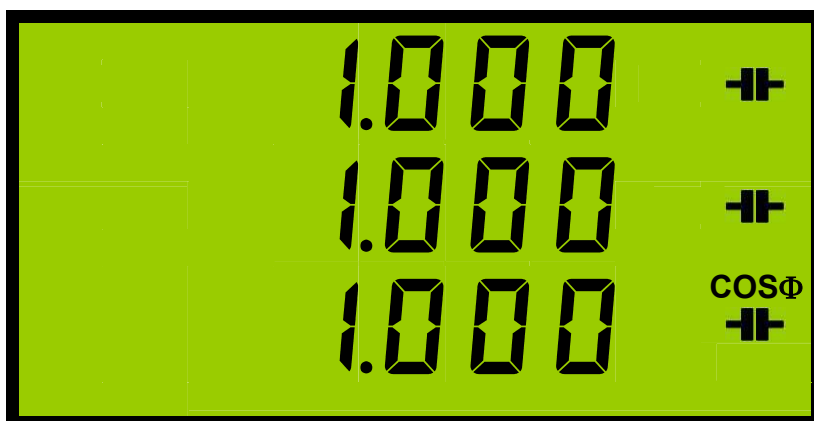

Phase Power Factor

Phase 1 Power Factor.
Phase 2 Power Factor.
Phase 3 Power Factor.

A  symbol after each value indicates a capacitive load.



Power Mean Demand (MD)

The calculated average of the system power values taken over a user definable time period T_p (1min to 60min).

A rolling time window is used and the display updated every $T_p/60$ with the averages of the most recent period displayed.



Peak Hold MD

The maximum value of each power MD value. These are stored in non-volatile memory when the meter loses auxiliary power

Press  and  to reset all three maximums to zero ^{note 1}.

NOTE 1: Meters may be installed with the option to reset all peak hold values using the front keys disabled.

2.5 Energy Menu

Press the  key to select from the available Energy Menu pages.



Real Energy (Wh)

This register accumulates only when real power (kW) is positive (import).

This value returns to 0 when the value exceeds 99999999.

This register is stored in non-volatile memory when auxiliary power is not supplied to the meter.



Reactive Energy (varh)

Import varh Accumulating register.

This value returns to 0 when the value exceeds 99999999.

This register is stored in non-volatile memory when auxiliary power is not supplied to the meter.



Apparent Energy (VAh)

Import VAh Accumulating register.

This value returns to 0 when the value exceeds 99999999.

This register is stored in non-volatile memory when auxiliary power is not supplied to the meter.

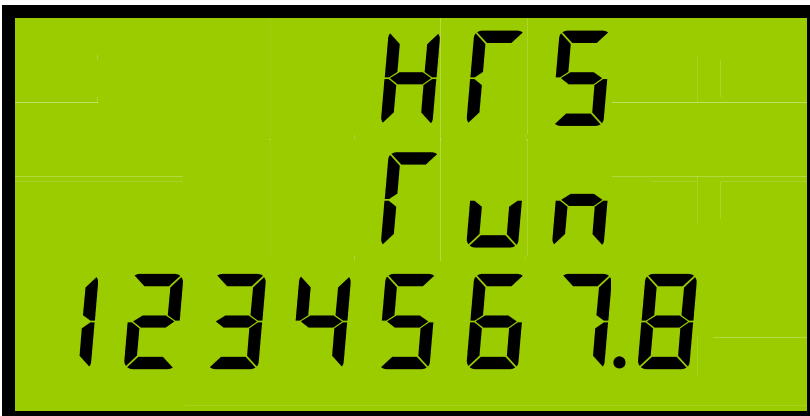

Hours Run ^{Note 2}

This register accumulates time in Hours only while real power (kWh) is above a user set level (see programming section).

This value returns to 0.0 when the value exceeds 99999999.

This register is stored in non-volatile memory when auxiliary power is not supplied to the meter.



Export kWh *Note 2*

This register accumulates only when real power (kW) is negative (export).

This value returns to 0 when the value exceeds 99999999.

This register is stored in non-volatile memory when auxiliary power is not supplied to the meter.



Export kvarh *Note 2*



This register accumulates only when reactive power (kvar) is negative (export).

This value returns to 0 when the value exceeds 99999999.

This register is stored in non-volatile memory when auxiliary power is not supplied to the meter.

NOTE 2: Hours Run, Export kWh and Export kvarh are factory fitted options. If these options are not supplied relevant page(s) will be omitted.

Meters may be supplied with an option to reset energy registers to zero using the front keys.

If the option is fitted, press  and  together and hold for approximately 3 seconds to simultaneously reset all energy registers to zero. Once reset the registers may not be recovered.

2.6 Power Quality Menus

NOTE: The power quality menus are only available on the Cube400 meter with the “Harmonic” option fitted.

To enter/exit power quality display mode press  and  together and hold for approximately 3 seconds.

2.6.1 Amps Power Quality Menu

Press the  key to select the Amps Power Quality Sub Menu. Press  or  keys to select the next/previous Amps Power Quality page.



Amps Total Harmonic Distortion

Phase 1 Amps THD

Phase 2 Amps THD.

Phase 3 Amps THD.

This display is updated every second.

THD is scaled as a percentage of the fundamental rms amps value. This example shows 20.0% THD.



Amps Individual Harmonics 02-15



Phase 1 Amps harmonic 02-15

Phase 2 Amps harmonic 02-15

Phase 3 Amps harmonic 02-15.

The harmonics are scaled as a percentage of the fundamental rms amps value. This example shows 10.0% second harmonic.

2.6.2 Volts Power Quality Menu

Press the  key to select the Volts Power Quality Sub Menu. Press  or  keys to select the next/previous Volts Power Quality page.



Volts Total Harmonic Distortion

Phase 1 Volts THD
Phase 2 Volts THD.
Phase 3 Volts THD.

This display is updated every second.

THD is scaled as a percentage of the fundamental rms volts value. This example shows 20.0% THD.

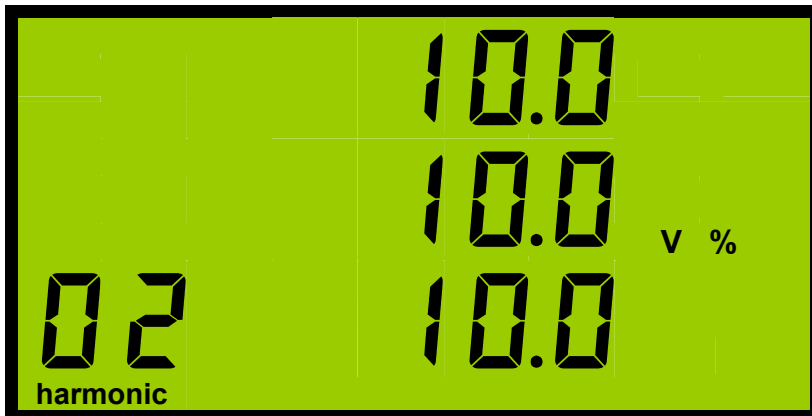

Volts Individual Harmonics 02-15

Phase 1 Volts harmonic 02-15
Phase 2 Volts harmonic 02-15
Phase 3 Volts harmonic 02-15.

The harmonics are scaled as a percentage of the fundamental rms volts value. This example shows 10.0% second harmonic.

2.7 Display Scaling

The units, Wh, kWh or MWh and the position of the decimal point for the energy/power displays are automatically set dependant on the **CT** and **PT** settings for the meter.

The nominal 3-phase input for the meter is defined as:

$$W_{nom} = \sqrt{3} \times U_n \times CT$$

Where: **Un** is the nominal Line-Line voltage or PT primary (10V - 440kV).
CT is the current sensor nominal primary (5A – 800A)
Un and **CT** are set in programming mode.

The display pages are scaled as follows:

2.7.1 Voltage Scaling

PT Setting (Un)	Resolution
10V _{L-L} - 80V _{L-L}	0.01 V
81V _{L-L} - 800V _{L-L}	0.1 V
801V _{L-L} - 8,000V _{L-L}	1 V
8,001V _{L-L} - 80,000V _{L-L}	0.01 kV
80,001V _{L-L} - 440,000V _{L-L}	0.1 kV

2.7.2 Current Scaling

CT Setting	Resolution
5A - 8A	0.001 A
9A - 80A	0.01 A
81A - 800A	0.1 A
801A - 8,000A	1 A
8,001A - 25,000A	0.01 kA

2.7.3 Power Scaling (W, VA, var)

PT Setting x CT Setting Un x CT	Phase Power Resolution	System Power Resolution
100VA - 1,400VA	0.1 W	0.001 kW
1,401VA - 14,000VA	0.001 kW	0.01 kW
14,001VA - 140,000VA	0.01 kW	0.1 kW
140,001VA - 1,400,000VA	0.1 kW	1 kW
1,400,001VA - 14,000,000VA	1 kW	0.01 MW
14,000,001VA - 140,000,000VA	0.01 MW	0.1 MW
140,000,001VA - 1,000,000,000VA	0.1 MW	1 MW

2.7.4 Energy Registers (Wh, VAh, varh)

PT Setting x CT Setting Un x CT	Resolution
100VA - 1,400VA	.001 kWh
1,401VA - 14,000VA	0.01 kWh
14,001VA - 140,000VA	0.1 kWh
140,001VA - 1,400,000VA	1 kWh
1,400,001VA - 14,000,000VA	0.01 MWh
14,000,001VA - 140,000,000VA	0.1 MWh
140,000,001VA – 1,000,000,000VA	1 MWh

2.7.5 Miscellaneous

All Settings	Resolution
System and Phase PF	0.001
Amps and Volts % THD	0.1%
Amps and Volts % Harmonic	0.1%
Frequency	0.1 hz

3 Installation

3.1 Mounting In a Panel

Panels should be 1mm to 4mm thick with a square cutout of 92mm (+0.8/-0.0mm). Insert the meter from the front of the panel, slide the panel clips from the rear of the case and push firmly against the panel ensuring even pressure on each clip.

3.2 Pulse Output Connection

The pulse outputs take the form of isolated volt free normally open contact pairs.

The contacts are isolated from all other circuits (2.5kV / 1 minute) and at 50V from pulse1 to pulse 2.

The pulses can be used as an input to a remote counter, pulse logger, building energy management system etc.

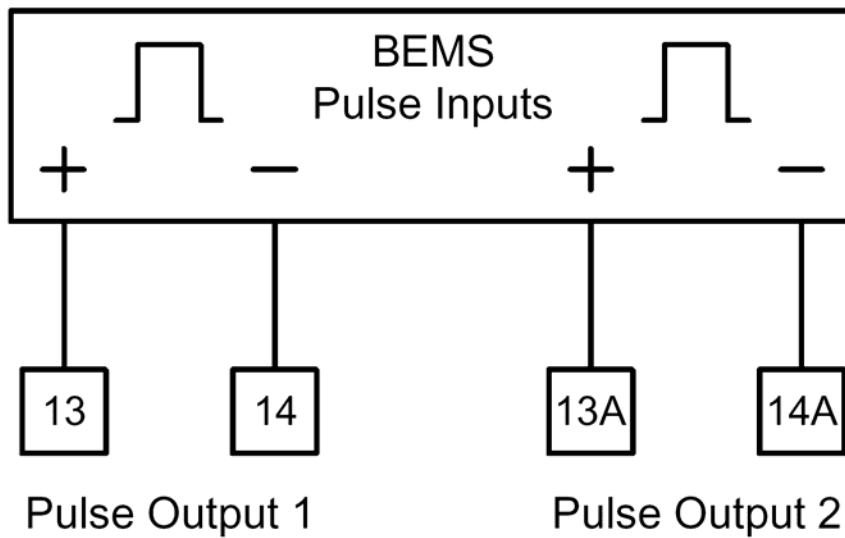

Pulse Output Connections

3.3 Input Connections

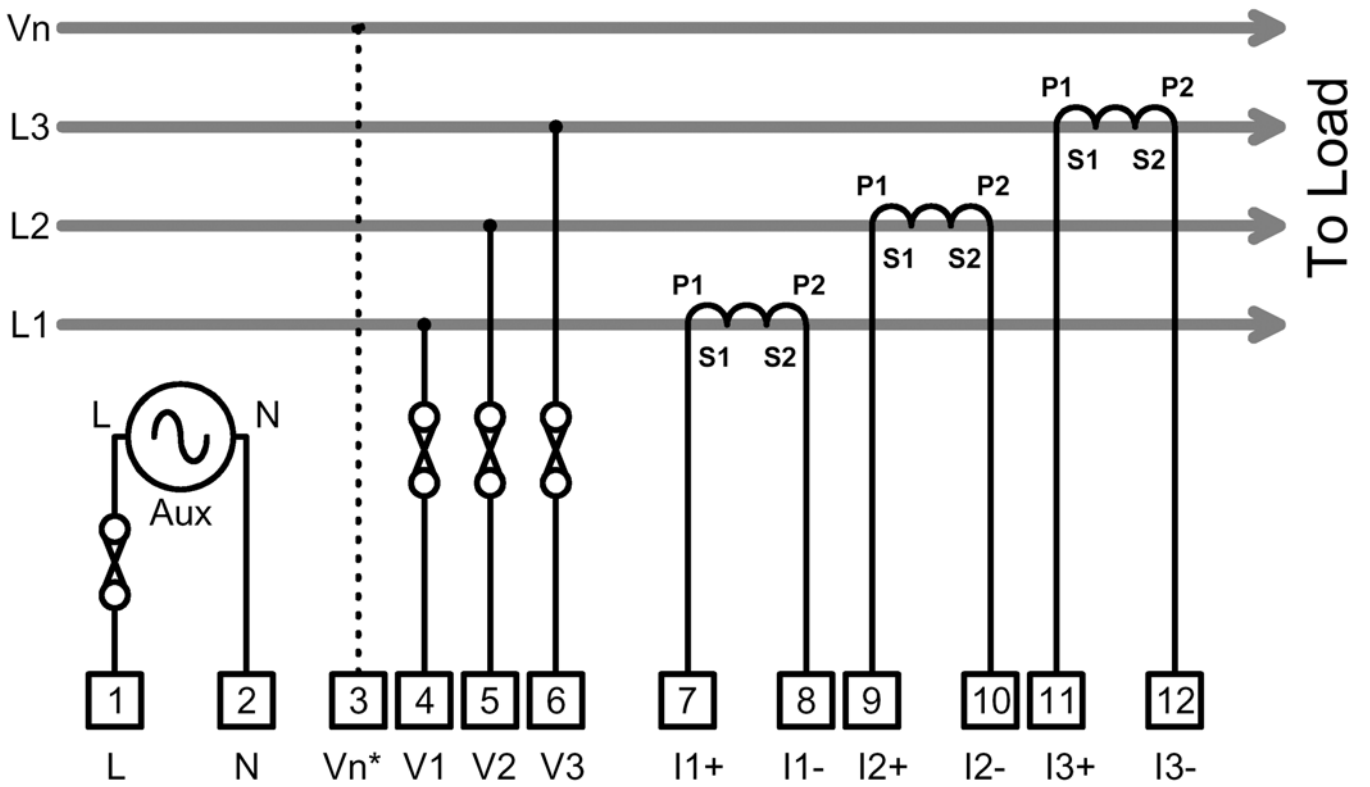

3-Phase 3 or 4-Wire (*Optional Neutral)

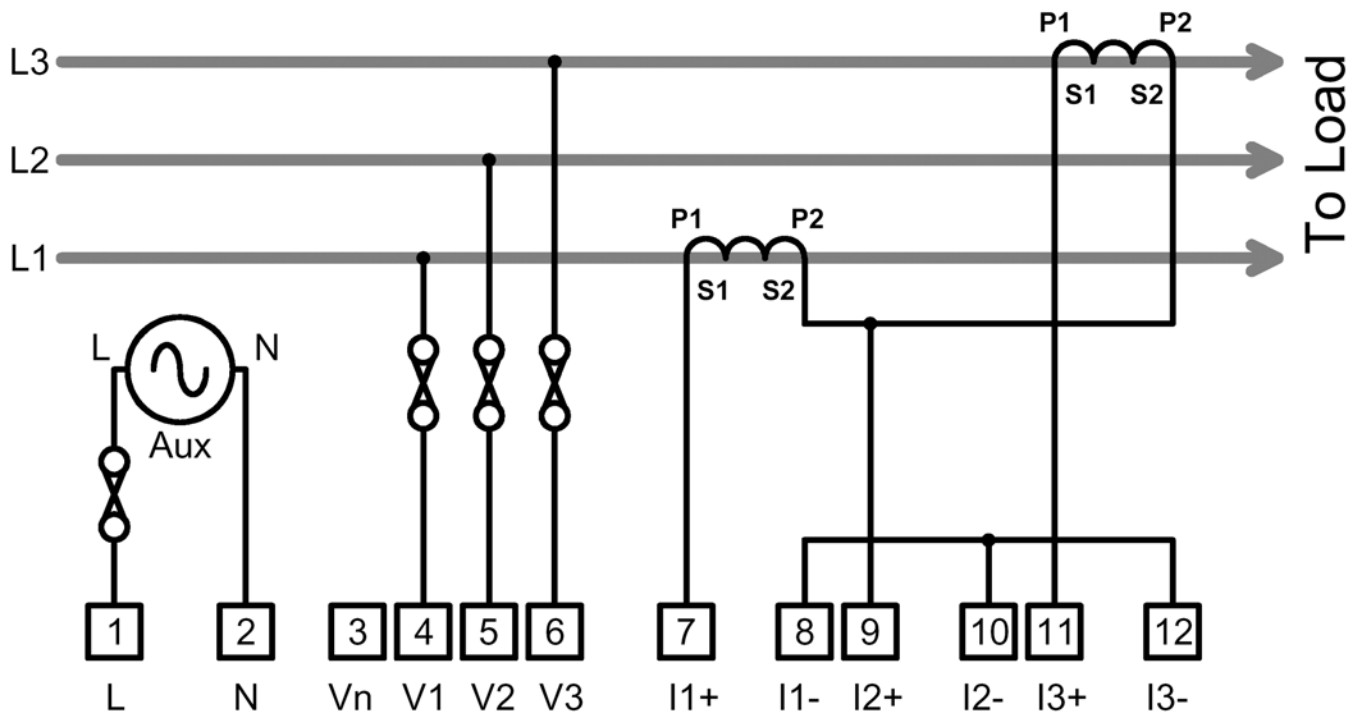

3-Phase 3-Wire

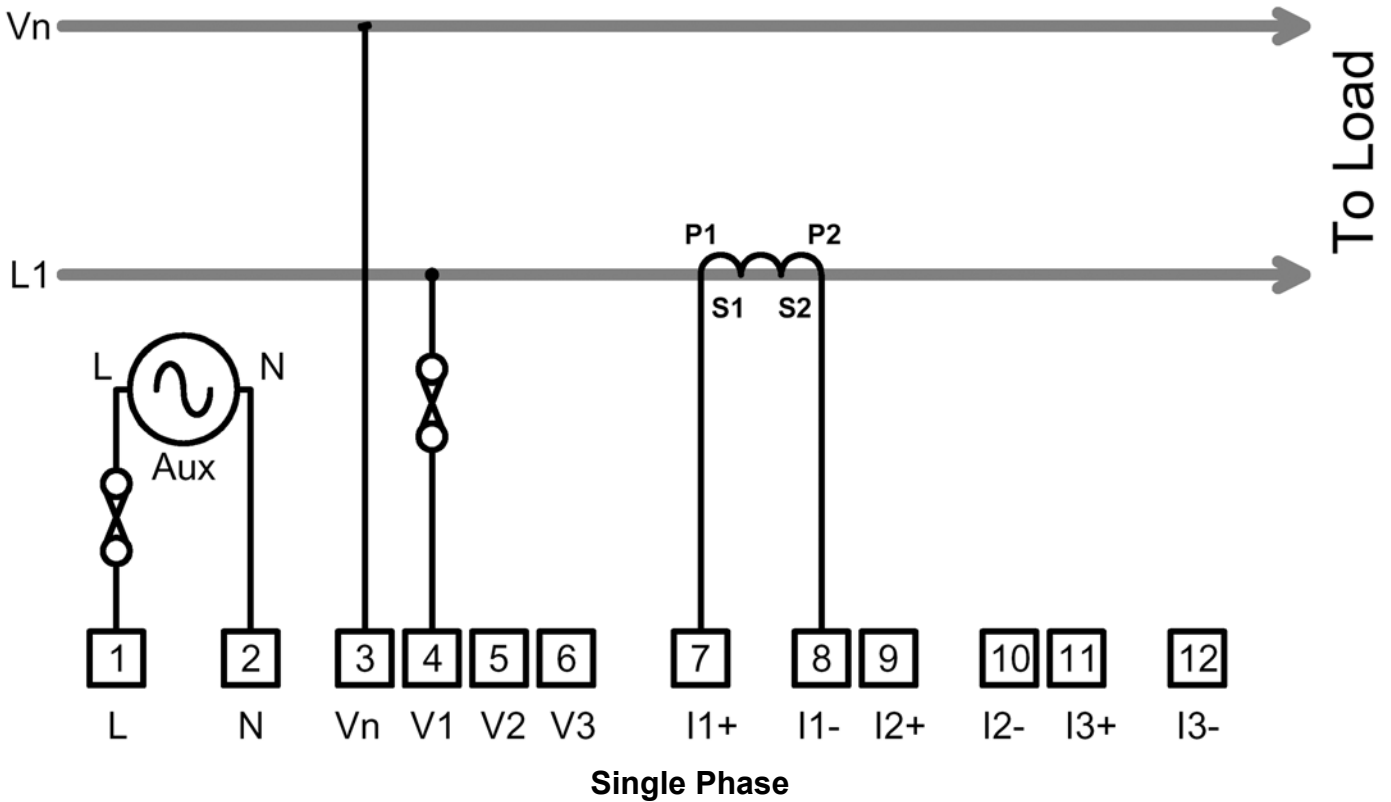
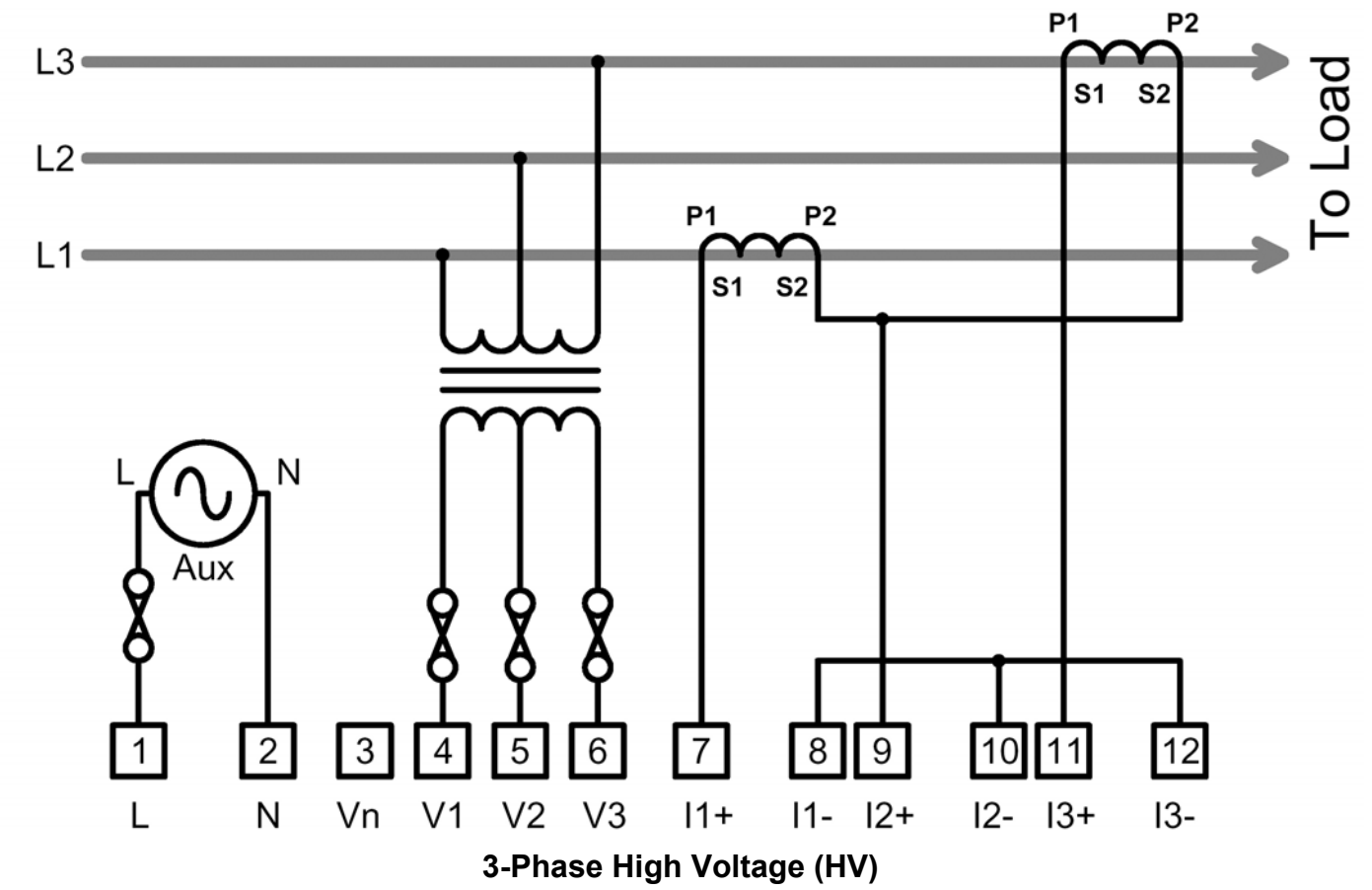

4 Pulse Outputs

Two isolated pulse outputs are provided for connection to external systems such as Building Energy Management Systems (BEMS), data loggers, remote counters etc.

Pulse 1 is always associated with the active energy (kWh) register.

Pulse 2 is normally associated with the reactive energy (kvarh) register but meters may be supplied with this pulse linked to the kVAh register.

A single pulse occurs for each unit of energy on the display (eg 1 pulse per 0.1kWh). The pulse rate (amount of energy associated with each pulse) and pulse length may be set to suit the external system.

4.1.1 Pulse LEDs

Light emitting diodes (LEDs) on the front panel of the instrument remain ON during each associated output pulse.



Pulse Output Indicators

5 Meter Setup

5.1 Programming Menu

To enter programming mode:

Hold  and  together for 5 Seconds.

4-Digit Security Code



This page is only shown if a **security code** greater than 0 is set via serial communication.

Press  or  to select each digit (least significant first)



Press  to move to the next most significant digit.

A correct 4 digit security code is required to access other programming menu pages.

Current Transformer Primary



Press  or  to select from the standard list of CT primaries while **L** is displayed. (List Mode)

Press  or  to increase or decrease the value by 10 while **F** is displayed. (Fine adjust)



Press  and  together to toggle between **L** and **F**.

Press  to accept the set value.

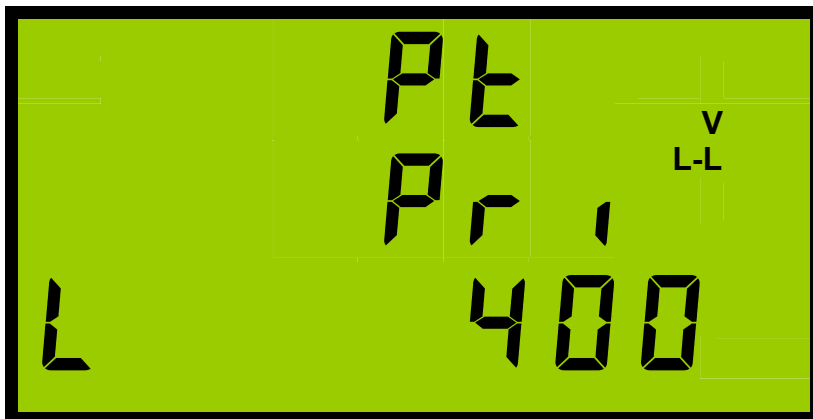
Potential Transformer Primary



Press  or  to select from the standard list of PT primaries while **L** is displayed. (List Mode)

Press  or  to increase or decrease the value by 10 while **F** is displayed. (Fine adjust)

Press  and  together to toggle between **L** and **F**.

Press  to accept the set value.

Power MD Integration Period *(Note 1)*

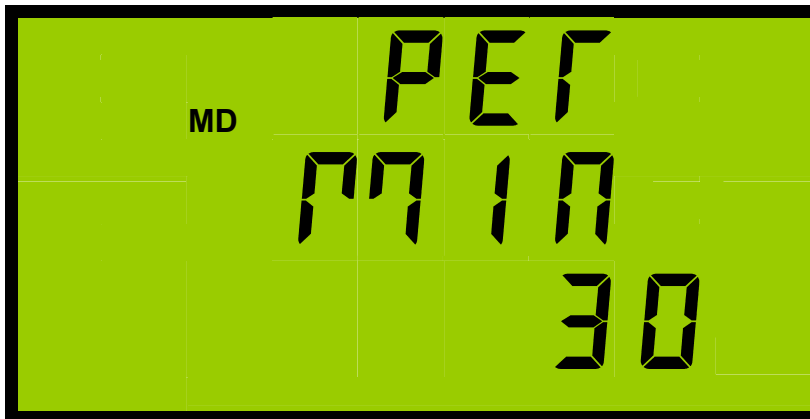

This sets the integration period in minutes used for the sliding time window MD calculation for power.

Press **P**  or **E**  to increment or decrement the value.

Press **I**  to accept the set value.

Current/Voltage Time Ave Period *(Note 1)*

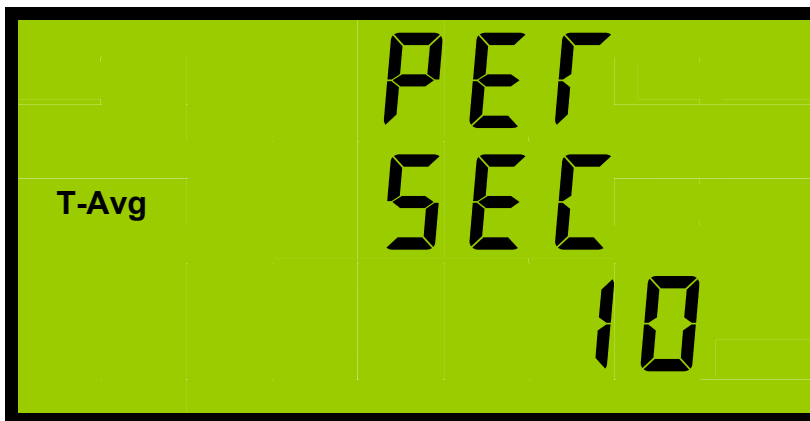

This sets the integration period in seconds used for the sliding time window average calculation for current and voltage.

Press **P**  or **E**  to increment or decrement the value.

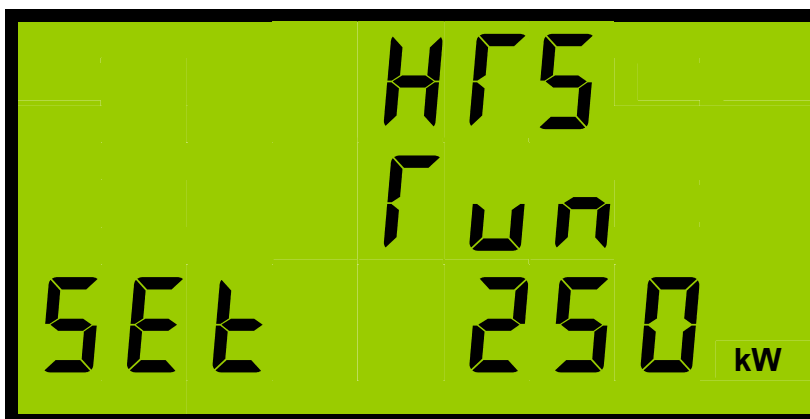

Press **I**  to accept the set value.

Hours Run Set Point *(Note 1)*



This sets the instantaneous system kW level above which the Hours Run timer will accumulate.

Below this level Hours Run will remain unchanged.

Press **P**  or **E**  to increment or decrement the value. The speed of change will increase as the button is held.

Press **I**  to accept the set value.

Pulse Rate



This sets the amount of energy (kWh) required to trigger each Pulse 1 output.

Pulse 2 is set at the same rate but linked to a different register (eg kvarh).

Press **P** or **E** to select the next/previous Pulse Rate from a standard list.

Press **I** to accept the set value.

Pulse Length

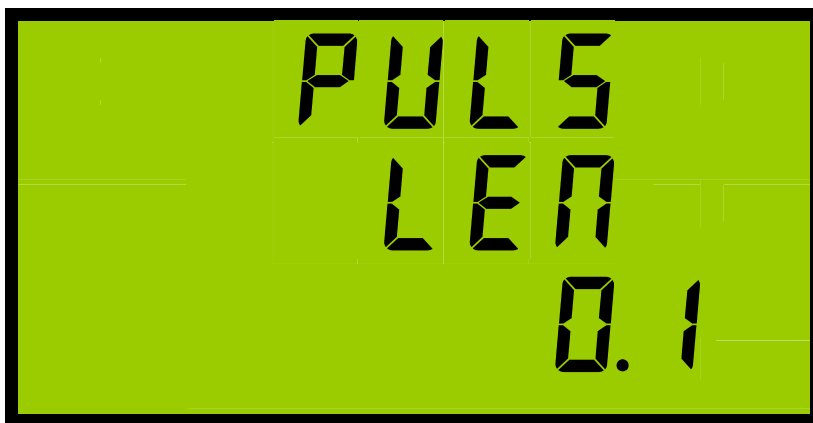

This sets the contact closure time for both pulse outputs.

Press **P** or **E** to select the next/previous Pulse Length from a standard list.

Press **I** to accept the set value.

Pulse Test

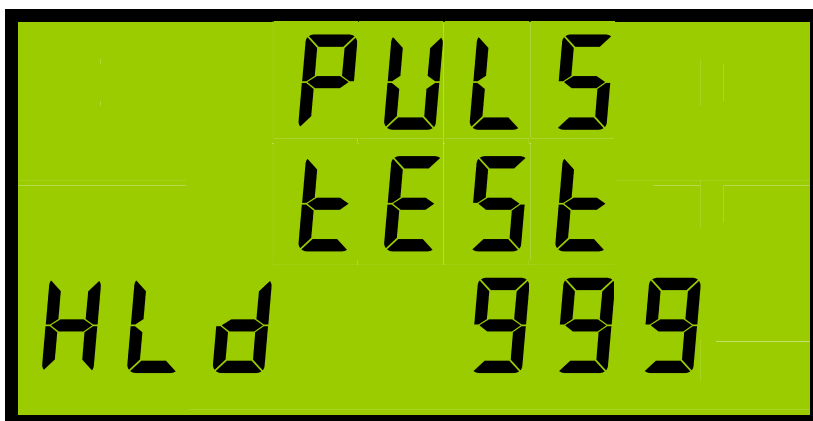

This allows the commissioning engineer to test both pulse outputs and associated circuits without the need of a test load.

Press **P** or **E** to start/stop a test pulse stream. The display shows *Hld* (Hold) or *Run* respectively.

The counter shows the total number of pulses during the test.

Press **I** and **V** to reset the test counter to zero.

Press **I** to accept the set value.

Note 1. Some setup screens are only available on meters with corresponding measurement options.

6 Specification

INPUTS	
System	3 Phase 3 or 4 Wire Unbalanced Load
Voltage Un	400/230V. 3 Phase 3 or 4 Wire 110/63V & 208/120V optional. Others to order.
Current In	5A from external CTs. 1A optional. Fully isolated
Measurement Range	Voltage 50% to 120% Un Current 0.2% to 120% In
Frequency Range	Fundamental 45 to 65Hz Harmonics Up to 30th harmonic at 50Hz Individual to the 15th
Burden	Voltage <0.1VA per phase Current <0.1VA per phase
Overload	Voltage x4 for 1 hour Current x40 for 0.5 second max
DISPLAY	
Type	Custom, Supertwist, LCD
Data Retention	10 years min. Stores kWh & Meter set-up
Format	2 Rows x 4 Digits, 1 Row x 8 Digits + Legends
Scaling	Direct reading. User programmable CT & PT CT Primary programmable from 10A to 25kA VT primary programmable from 10V to 440kV
Legends	Wh, kWh, MWh etc. depending on user settings
AUXILIARY SUPPLY	
Standard	230V 50/60 Hz $\pm 15\%$
Options	110V 50/60 Hz $\pm 15\%$
Load	3VA max.
Overload	x1.2 continuous
METER ACCURACY All errors ± 1 digit	
kWh	Better than Class 1 per EN 62053-21 & BS 8431
Kvarh	Better than Class 2 per EN 62053-23 & BS 8431
kW & kVA	Better than Class 0.25 IEC 60688
kvar	Better than Class 0.5 IEC 60688
Amps & Volts	Class 0.1 IEC 60688 (0.01In – 1.2In or 0.1Un – 1.2Un)
PF	$\pm 0.2^\circ$ (0.05In – 1.2In and 0.2Un – 1.2Un)
Neutral Current	Class 0.5 IEC 60688 (0.05In – 1.2In)

PULSE OUTPUTS	
Function	1 Pulse per unit of energy
Scaling	Settable between 1 & 1000 counts of energy register
Pulse Period	0.1 sec. default; Settable between 0.1 and 20 sec
Rise & Fall Time	< 2.0ms
Type	N/O Volt free contact. Optically isolated BiFET
Contacts	100mA ac/dc max ; 100V ac/dc max ; 5W maximum load
Isolation	2.5kV 50Hz 1 minute
MODBUS® Serial Comms (Option)	
Bus Type	RS485 2 wire + 0v. ½ Duplex, ¼ unit load
Protocol	MODBUS® RTU with 16 bit CRC
Baud Rate	4800, 9600 or 19,2000 User settable
Address	1 – 247 User settable
Latency	Reply within 250ms max.
Command Rate	New command within 5ms of previous one
GENERAL	
Temperature	Operating -10°C to +65°C Storage -25°C to +70°C
Humidity	< 75% non-condensing
Environment	IP54 standard, IP65 optional
MECHANICAL	
Terminals	Rising Cage. 4mm ² (12 AWG) cable max.
Enclosure	DIN 43700 96 x 96
Material	Mablex® with fire protection to UL94-V-O. Self extinguishing
Dimensions	96 x 96 mm x 83.5 mm (72 mm behind panel)
Weight	~ 250 gms
SAFETY	
Conforms to	EN 61010-1 Installation Category III & BS 8431

E. & O. E.

© Northern Design (Electronics) Ltd, April 2008