

User Manual
Revision 2.002
English

Smart energy meter

OB737 0.075-1.5(6)A



Benefits and Main Features

- Three phase metering
- Standard DIN rail Format (DIN43880)
- EN50470-3 Class B.
- Import &Export active energy
- Import &Export reactive energy
- Instantaneous Volt, Amp, Power factor, Frequency, Active power, Reactive power, Apparent power
- Isolated pulse output and IR (DIN43864)
- LCD display, 6 integer 2 decimal
- Large clear backlit display
- Internal transformer
- 27 CT rates can be selected
- Optional single-phase model
- RS485 communication port, Modbus protocol
- IR port
- Programed via buttons on the nameplate
- Memory back-up (EEPROM)
- 7 DIN modules
- MID approval, Annex B & D
- The meter is intended to be installed in a Mechanical Environment 'M1', with Shock and Vibrations of low significance, as per 2004/22/EC Directive and should be installed in Electromagnetic Environment 'E2', as per 2004/22/EC Directive.

Index:

1. Safety notice

2. Content of delivery

3. Declaration of Conformity

4. Technical description

4.1 Performance criteria

4.2 Meter specification

4.3 Dimensions and sealing points

5. Wiring diagrams

6. Meter reading

7. Main function

7.1 Measuring Function

7.2 Display function

7.3 Electricity parameters measurement and monitoring

7.4 Communication Function

7.5 Alarm function

7.6 Pulse output function

8 Programming

8.1 Password verify

8.2 ID setting

8.3 Baud rate setting

8.4 CT rate setting

8.5 Password setting

9. Technical support

3. Declaration of Conformity

1. Safety notice

PLEASE NOTE: WE SUPPLY THESE METERS ON THE ASSUMPTION THEY WILL BE INSTALLED BY A QUALIFIED ELECTRICIAN FAMILIAR WITH THE INSTALLATION OF METERING EQUIPMENT.

ENSURE CT'S ARE INSTALLED AS PER WIRING DIAGRAM (CORRECT POLARITY OF CT'S).

I.E.

P1 = MAINS.

P2 = LOAD OUTGOING.

CHECK SECONDARY 1 (S1) AND SECONDARY 2 (S2) ARE CORRECT AS PER WIRING DIAGRAM OTHERWISE THE METER WILL RUN IN REVERSE.

FOR HEALTH AND SAFETY REASONS IT SHOULD BE NOTED IF A CURRENT TRANSFORMER IS OPERATED WITH THE SECONDARY OPEN CIRCUITED, 50V RMS OR MORE MAY BE GENERATED AT THE SECONDARY TERMINALS OR LEADS.

All meters must be installed according to applicable wiring diagram. Incorrect connections to the electricity network will causes major display problem and can also cause serious damage to the meter.

Before starting meter operation, it must be ensured local conditions of the energy system are consistent with the meter type and configuration. Make sure that cables (conductors) are not damaged during installation of the meter, not energized and are appropriate for the installation in question.

Capacitors within the meter may still be charged even after disconnection from all energy sources.

2. Content of delivery

Three phase, electronic energy meter, instructions for assembly

ID setting

Baud rate setting

CT rate setting

Password setting

4. Technical description

4.1 Performance criteria

Operating humidity	≤ 75%
Storage humidity	≤ 95%
Limit range of operating temperature	-25°C - +55°C(3K6)
Limit range for storage temperature	-25°C - +55°C(1K4)
Humidity	75% yearly average, 95% on 30 days/year
International standard	EN50470-3 & IEC62053-21
Accuracy class	Class B
Protection against penetration of dust and water	IP51
Insulating encased meter protective class	
Connection area main terminals (Indoor meter)	
Current terminals flexible 1×mm ²	0-16mm ²
Other terminals flexible 1×mm ²	0-2.5mm ²

4.2 Meter specification

	Direct connected meters
Voltage(v)	3 × 230/400V
Operational voltage	±70%Un
Current(A)	
- Iref	1.5A

-Itr	0.15A
-Imax	6A
-Imin	0.075A
-Ist	3mA
Power consumption of current circuits(VA)	< 0.01
Power consumption of voltage circuits(W)	< 1.3W
General data	
Frequency (Hz)	50
Memory back-up	EEprom
Environment resistance to heat and fire	Terminal 960°C Cover 650°C
Upper	ABS+PC
Lower	ABS+PC
Pulse output	
Pulse width(ms)	80
Pulse constant(imp/kWh)	6400
LED constant	6400
Width (mm)	126
Height (mm)	104.5
Depth (mm)	60

4.3 Dimensions and sealing points

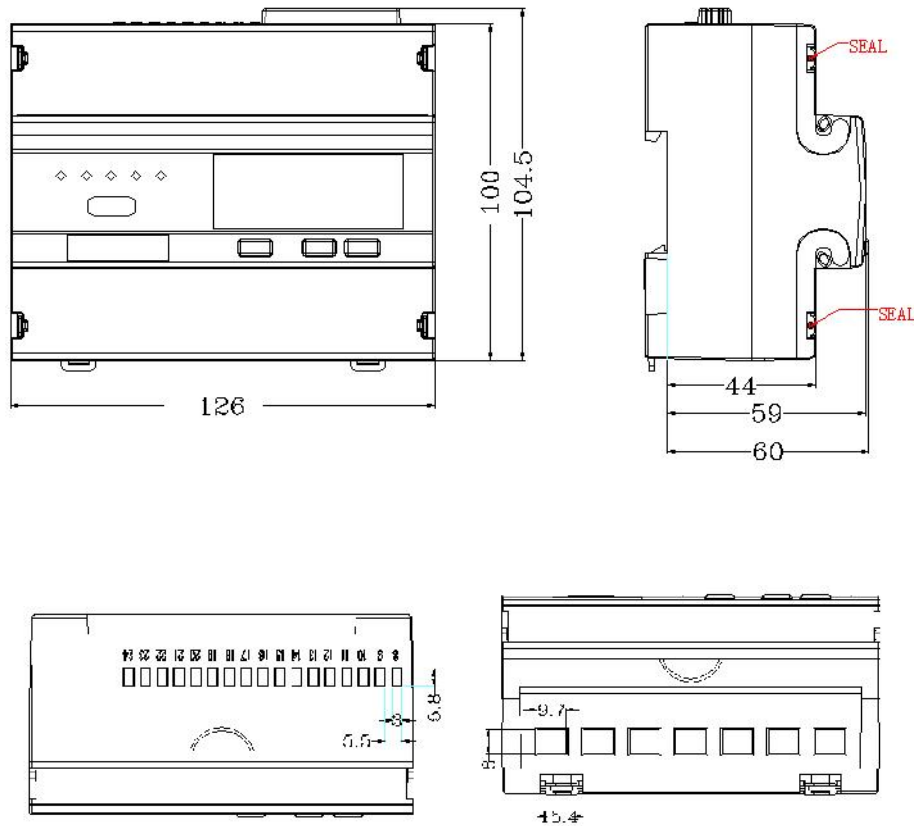

5 Wiring diagrams

Note: the following types of wiring diagrams show the energy meter, including terminals for pulse output and RS-485 communication interface.

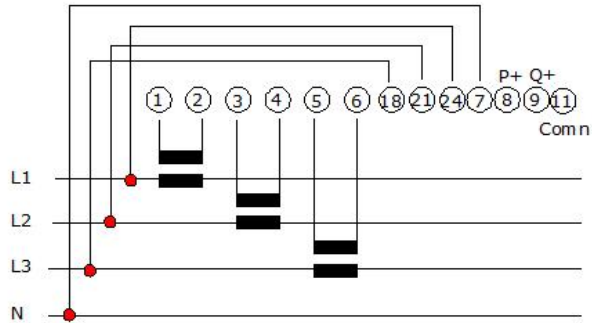

- 1/2 L1 in & out
- 3/4 L2 in & out
- 5/6 L3 in & out
- 24/21/18/7 UL1, UL2, UL3, N
- 8 & 11 Active test pulse output contact (11 — ,8+)
- 9&11 Reactive test pulse output contact (11 — ,9+)
- 12&13 RS485 communication contact (13 TX/RX (-), 12 TX/RX (+))

6 Meter reading

Ideal viewing angle

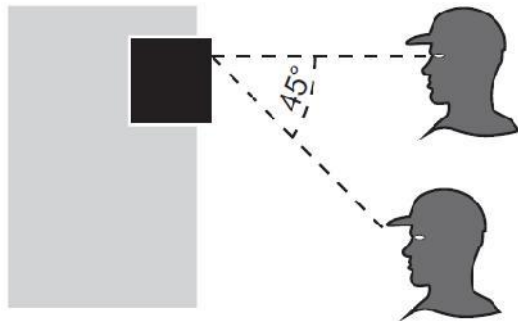

7 Main functions

7.1 Measurement

On the OB737'S front panel, there are three, active/reactive energy pulse LED's, and alarm indicator LED's.

The meter can measure import & export active energy, import & export reactive energy.

The measurement parameters can be set.

7.2 Display

The Smart meter has two display cycles: auto display cycle and manual display cycle (using buttons). When pressing the buttons, the user can view or program the meter parameters. Pressing the button will illuminate the LCD. Display cycles can be programmed @ 5~20 second intervals, the default is 5 seconds. The display items are as follows:

Code	Display item	Code	Display item
0010	UL1	0110	QL1
0012	UL2	0112	QL2
0014	UL3	0114	QL3
004E	Frequency	0116	ΣQ
0050	IL1	0150	PFL1
0052	IL2	0152	PFL2
0054	IL3	0154	PFL3
0056	In	0156	ΣPF
0090	PL1	0524	Modbus id
0092	PL2	0525	RS485 Baud rate
0094	PL3	0A00	Import Reactive Energy

0096	ΣP	0B00	Export Reactive Energy
00D0	SL1	0700	Total Active energy
00D2	SL2	0800	Import active energy
00D4	SL3	0900	Export active energy
00D6	ΣS	FF00	High byte of serial number
Code	Display item	Code	Display item
FF01	Low byte of serial number	FF09	Meter's constant

LCD content

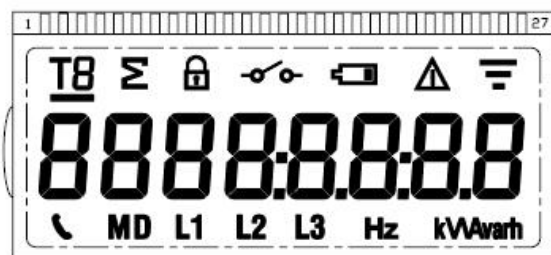

Description of LCD symbols displayed

Symbol	Description
	kWh—active energy kW—active power kvarh—reactive energy kvar—reactive power kVA—apparent power
	Total
	Unpermitted programming

	LCD alarm indicator
	Communication symbols

7.3 electricity parameters measurement and monitoring

Measure record and display voltage, current, power and power factors. error is not more than $\pm 1\%$.

7.4 Communication

With infrared and RS485 communication. Both physical layers are independent of each other. One communication channel will not be affected by the other. The meter can realize data acquisition, broadcast time setting, read, program and management through hand-held terminals, data acquisition terminal, test equipment and computers.

Communication protocols fits Modbus RTU standard.

RS485 and energy meter internal circuits have electrical isolation and failure protection.

RS485 communications transfer rates allow selected at 1200bps, 2400bps, 4800 bps and 9600bps, default is 9600bps.

7.5 Alarm

If installed incorrectly, example: current reverse, lost phase or reversed phase sequence, the meter will display & the ALARM led will be illuminated.

7.6 Pulse output

The OB737 Smart Meter is equipped with a pulse output which is fully separated from the live circuit that generates pulses in proportion to the measured energy, including the testing pulse output of active energy and reactive energy. 8/ 11 Test pulse output contacts (P+/P-), 9/ 11 Test pulse output contact (Q+/Q-)

The pulse output is a polarity dependent, passive transistor output requiring an external voltage source for correct operation. For this external voltage source, the voltage (U_i) should be 5-27V DC, and the maximum input current (I_{max}) should be 27mA DC. To connect the impulse output, connect 5-27V DC to connector 8&9 (anode), and the signal wire (S) to connector 11 (cathode). The meter pulse is indicated on the front panel.

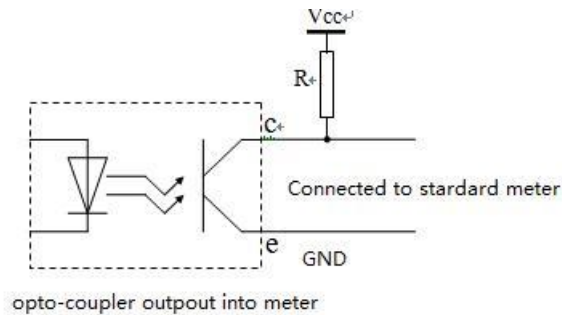

8 Programming

By holding the keys "SET" pressed for at last 3 sec., starts menu programming mode.

LCD will show:

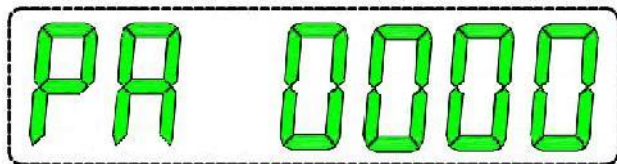

8.1 password verify

On the smart meter display will appear: PA followed by the currently memorized value. "PA" means "Password"; "0000" means the 4 digits of the Password. we can use press "Page Down" button to decrease the input value, and press "Page Up" to increase the input value, press the "SET" button to switch the input Password digits, when the Password is correct, the meter will enter "program status" and display the "ID" program interface.

Please note:

Please remember the Password, Password default (8888).

8.2 ID setting

After the Password authentication, the meter will display the "ID XX" setup interface. As the following picture "Id 00" it means the current ID address is 00 (the ID address is hex code)



Press "Page Down" button to decrease the digits. Press "Page Up" to increase the digits, press "SET" button to save the setup, the interface will switch to baudrate setup interface automatically. Press "SET" button to enter next interface if you do not need to change the baudrate.

8.3 Baud rate setting



we can use press “Page Down” button to decrease the input value, and press “Page Up” to increase the input value ,press the “SET” button to switch the input digits, when the baudrate is correct, the meter will enter “program status” and display the “CT” program interface.

Remarks:

1. Default baudrate will be 9600bps
2. 1200/2400bps /4800bps/9600bps can be set

8.4 CT rate setting



Press “Page down” and “page up” buttons to select the Current Transformer ratios press “SET” button to save the setup. The interface will enter Password setup.

CT Ratio	5:5	5:50	5:60	5:75	5:100	5:125	5:150	5:160	5:200
	5:250	5:300	5:400	5:500	5:600	5:750	5:800	5:1000	5:1200
	5:1250	5:1500	5:2000	5:2400	5:2500	5:3000	5:4000	5:5000	5:6000
	5:7500								
Please Note	When CT ratio is lower than 200, there is 1 digit decimal, when CT ratio is equal or higher than 200, there is no decimal place.								

Please note:

- 1, if the meter is a direct connected type, it has no CT setup interface.
- 2, after the CT ratio setup, the energy consumption display will be reset to 0.

8.5 Password setting:

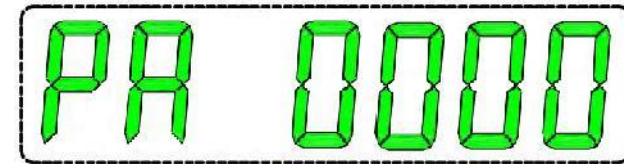

The meter will display the current default password after you enter the password setup interface; press the “SET” to change the password. Use “page down” and “page up” button to input password as you want. After 30 seconds the meter will save the password you programmed.

Please note:

- 1 Do not forget the password you setup.
- 2 Please press scroll through to check if setup is correct after programing.
- 3 Password setup interface “-” symbol will blink.

9. Technical support